



FLEXIBLE TABLES

arper

CROSS



CROSS

- Table and Bar Height
- Lengths range from 62" - 153" with Optional Linking Leg and Widths range from 25" - 53"
- Legs can be Inset or Flush at Edge
- **Customization Available** - Height, Width, Length, Electrification and Cable Management (Concealed in Leg and Trough)
- Three edge thicknesses that scale with length
- Wood Veneer / Fenix and Abet Laminates

arper

FLEXIBLE TABLES



CROSS | WHITE LAMINATE

arper
WHAT'S NEW!

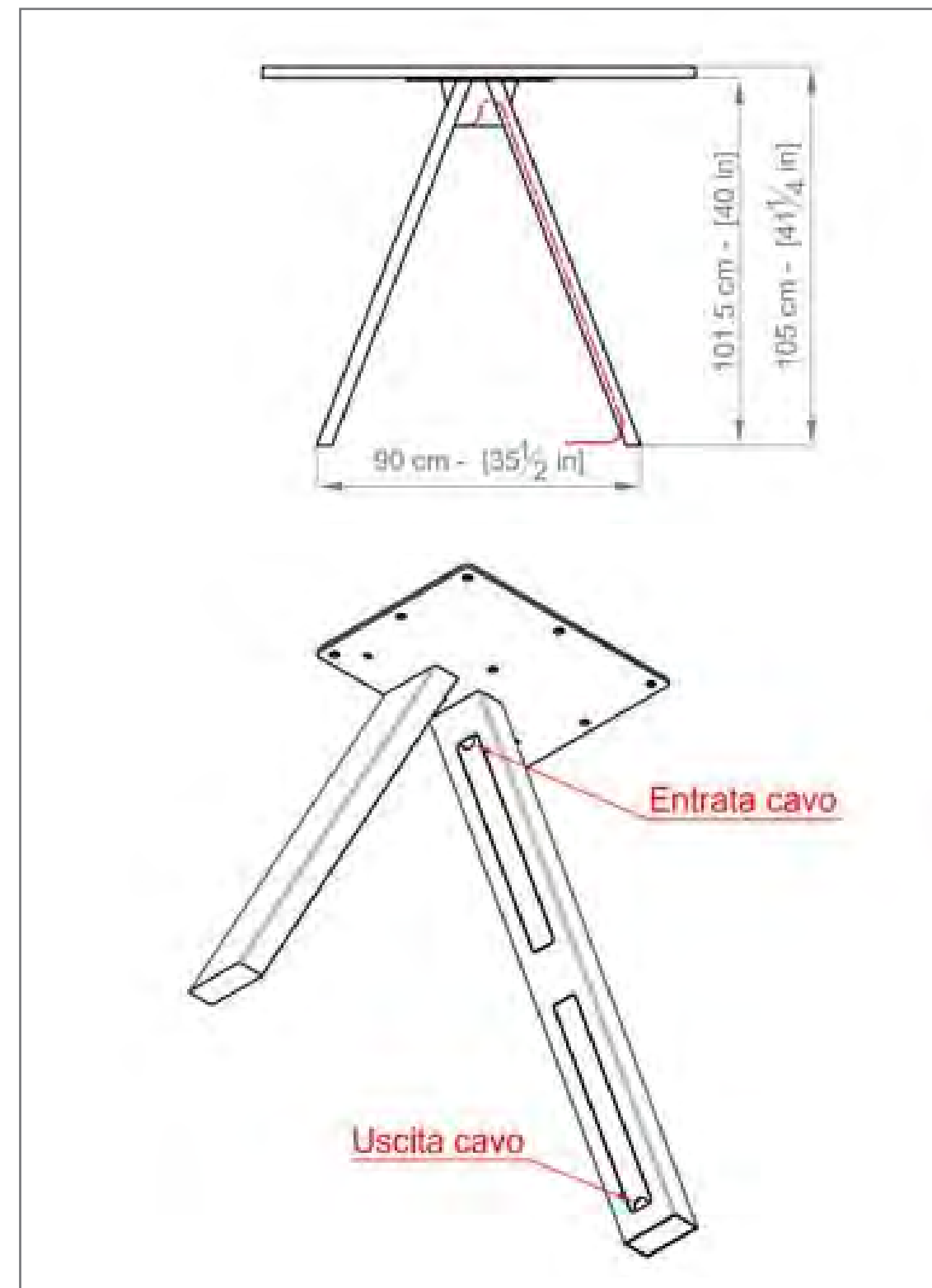

CROSS | LEG ELECTRIFICATION



CROSS | WHITE LAMINATE

arper
WHAT'S NEW!

13' L x 52" W
TABLE



CROSS | WHITE LAMINATE

arper
WHAT'S NEW!

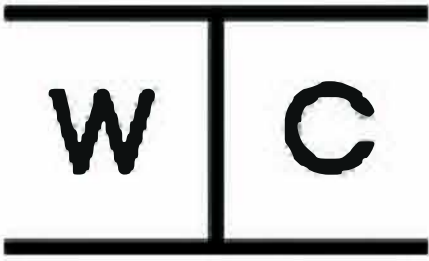

VISTA



VISTA

- **Heights:** Ranges from 29" - 42"
- **Tops:** Square and Rectangular in Wide Variety of Depths + Widths
- **Base Finishes:** Powdercoated and Stainless Steel
- **Surface Finishes:** Laminate, Wood, Ply, Solid Wood, Butcher Block, Corian, and Quartz
- **Suitable Options for Outdoor Use**

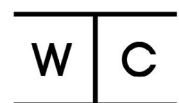



FLUSH WHEN
PUSHED TOGETHER



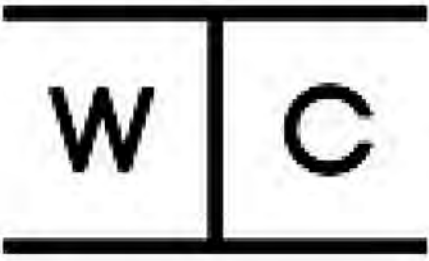

PARSONS



PARSONS

- **Heights:** Occasional (18"-24") Dining + Bar (29"-42")
- **Tops:** Square and Rectangular in Wide Variety of Depths + Widths
- **Surface Finishes:** Laminate, Wood Veneer and Solid Wood

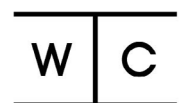

DINING SOLUTIONS





PANEL

- **Height:** 29" - 42"
- **Tops:** Square, Rectangular and Round in Wide Variety of Diameters + Sizes
- **Surface Finishes:** Laminate, Veneer, Ply, Solid Wood, Corian, Acrylic

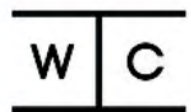



CONCEALED
POWER & CABLE
MANAGEMENT IN LEG

Wilkhahn

V E R S A



Wilkhahn

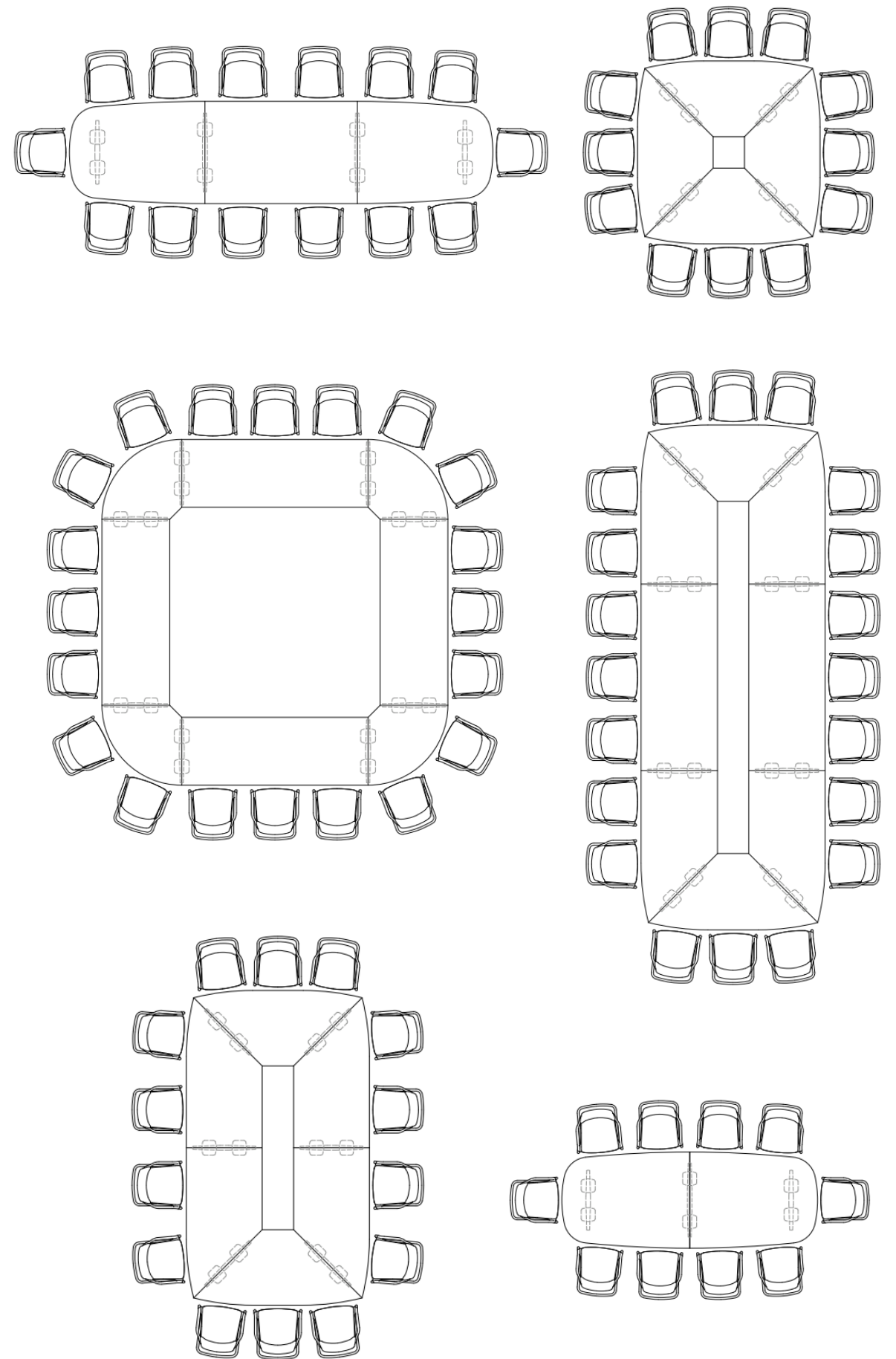

VERSA

- Adaptable Table with Connecting Bayonet Locking Legs
- Stackable with 3 different trolleys
- Table Systems can be set up, extended, made smaller and dismantled in little time without any tools or loose connecting parts.
- Laminate or Veneer Tops in Various Edge Profiles

VERSA



Wilkhahn

MAX



Wilkhahn

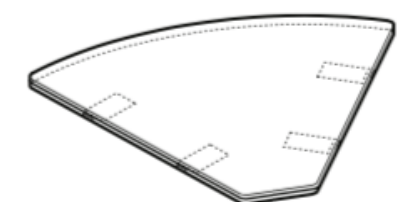
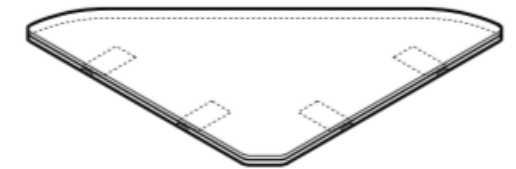
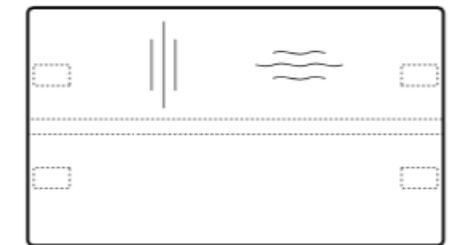
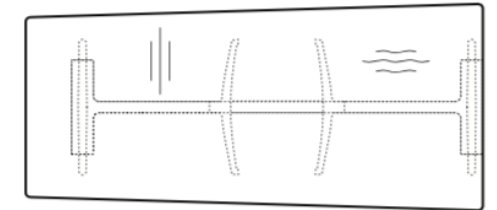
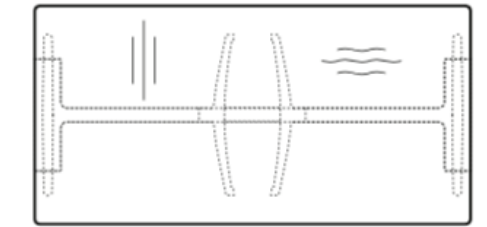

MAX

- Folding Leg Table
- Stacks 10 High Freestanding | 8 on a Trolley
- Various Depths, Widths and Sizes as well as Connecting Leaves to create a Broad Range of Design Options.
- Laminate or Veneer Tops with straight wood lipping all the way around or color-matching plastic bullnose bumper

Wilkhahn

FLEXIBLE TABLES

MAX

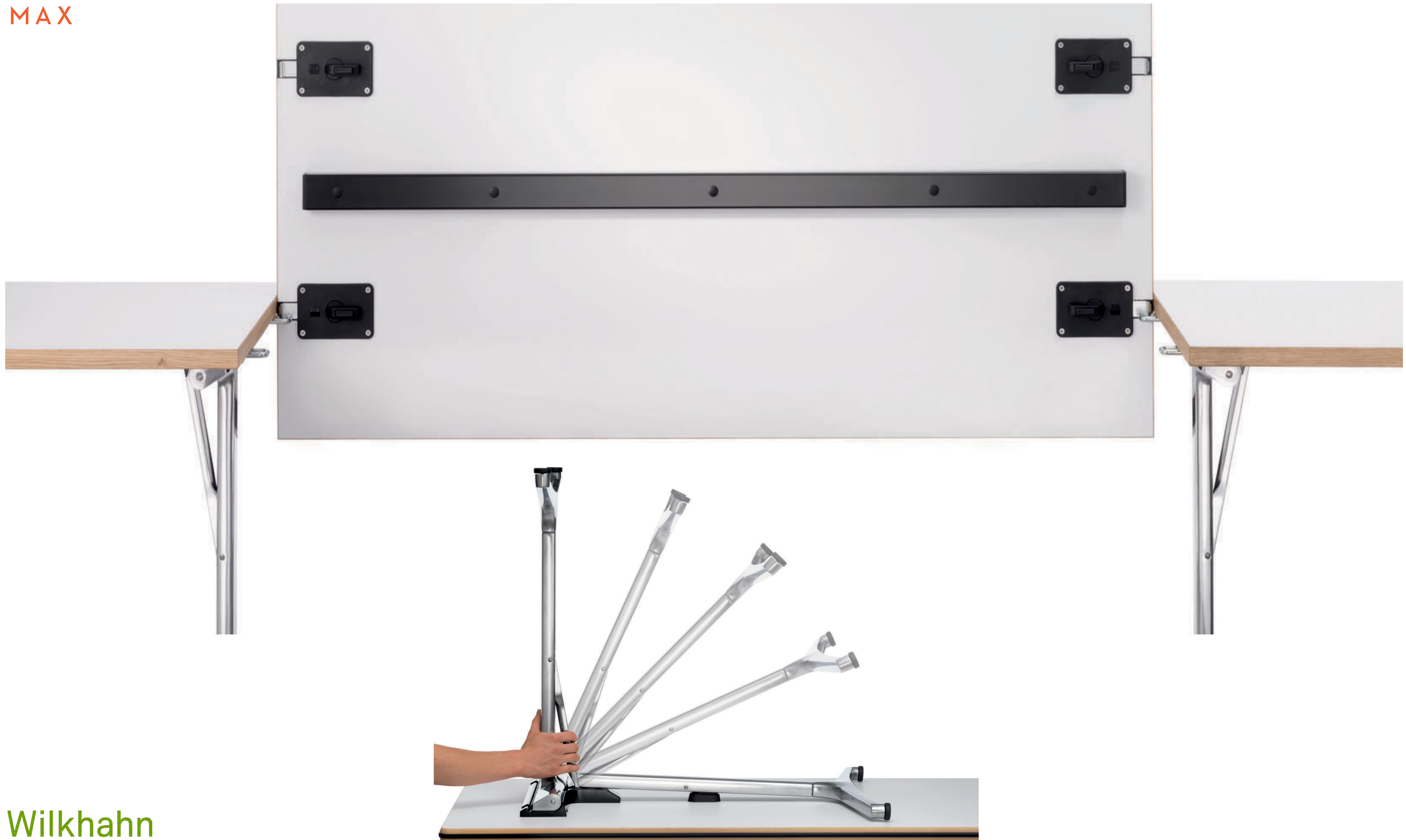



Wilkhahn

TIMETABLE COLLECTION

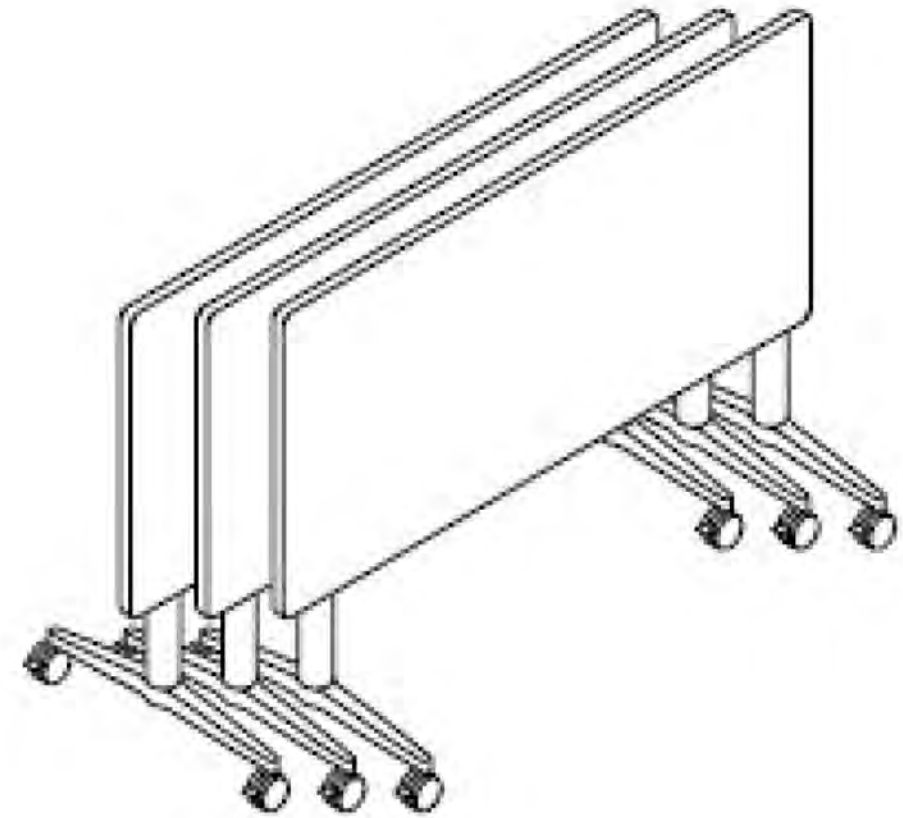

TIMETABLE LIFT

- Electrically Height Adjustable (28" - 54") with Optional Battery Pack
- White Table Top Surface can be written and is optionally magnetic for use as a whiteboard & projection screen
- Flip Table-Top allows for Nesting with Locking Swivel Castors
- Variety of Edge Profiles -- Bullnose double with integral, impact-resilient profile, Straight with integral, impact-resilient profile or Straight plastic edging



Bullnose edge with a black impact-resilient profile, table top 26 mm thick



Bullnose edge with a white impact-resilient profile, table top 26 mm thick



Coated bullnose edge with a black impact-resilient profile, table top 26 mm thick



Straight edge with a black impact-resilient profile, table top 26 mm thick



Straight edge with a white impact-resilient profile, table top 26 mm thick



Straight plastic edge, table top 25 mm thick





612 Timetable Smart nested (10 tables)

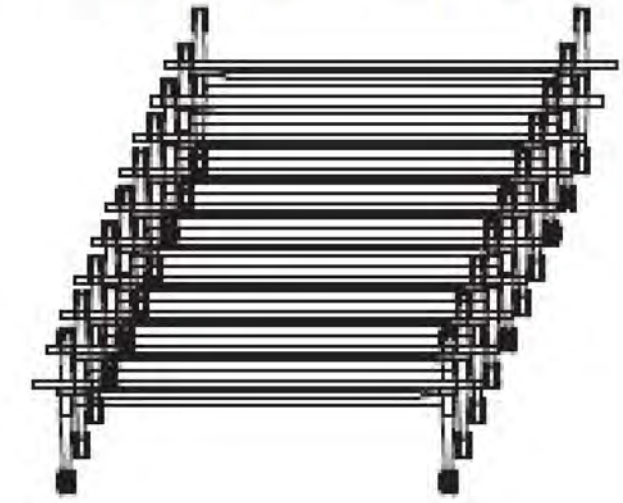

Shapes

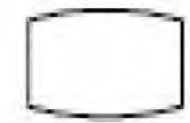

TIMETABLE SMART

- Flip Top and locking mechanism allow for staggered compact nesting capabilities
- Variety of Shapes allow for multitude of configurations: Rectangular, Circle, Elliptical or Circular Segment
- Available up to 72" Long and 30" Wide
- Variety of Edge Profiles -- Bullnose double with integral, impact-resilient profile, Straight with integral, impact-resilient profile or Straight plastic edging
- Optional Wiring to include Power and Data options

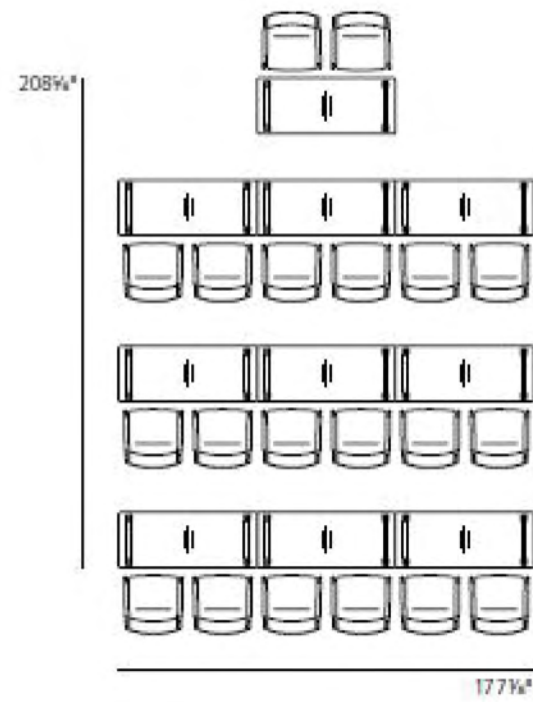
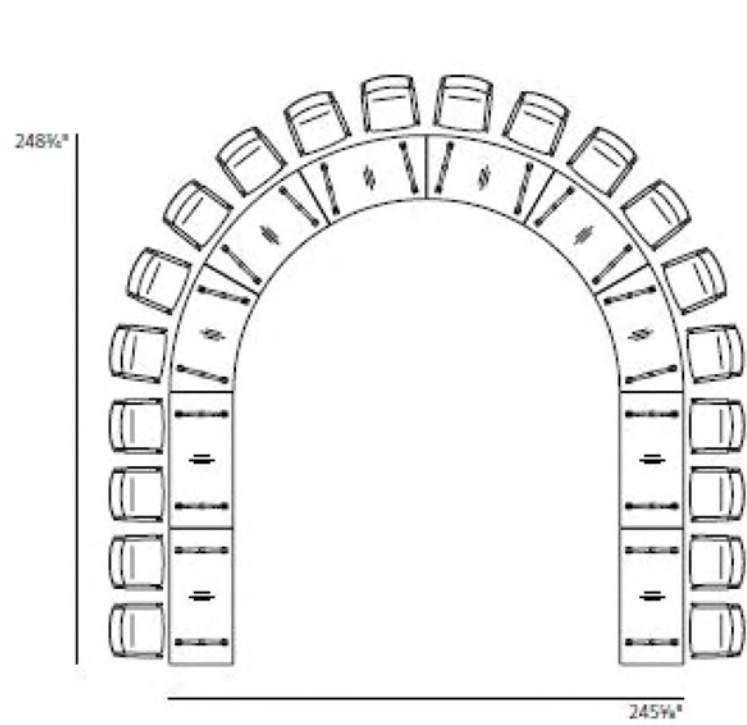

20 People
10 x 61 1/2 / 51, 59" x 23 1/2"





614 Timetable Shift nested (10 tables)

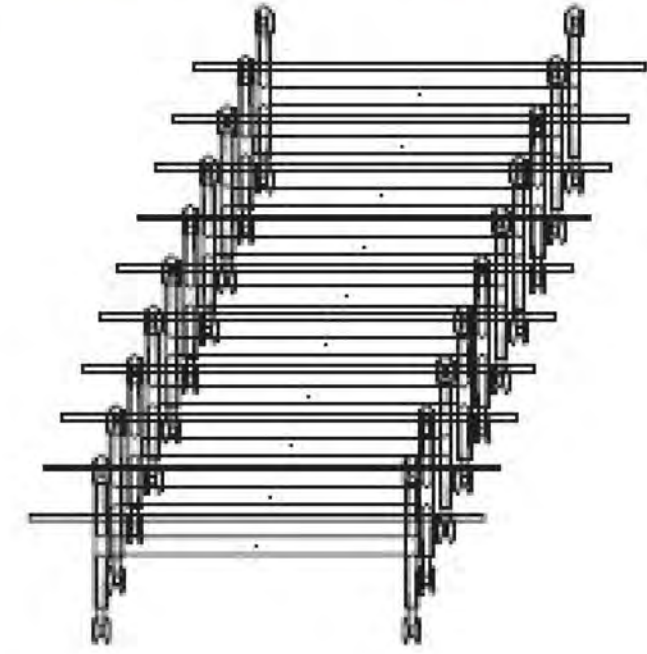

Shapes

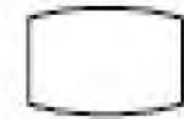

TIMETABLE SHIFT

- Flip Top with lockable castors allows for Nesting Capabilities
- Double Upright Leg and Foot serves as a spacious cable channel for Power and Data
- Variety of Shapes allow for multitude of configurations: Rectangular, Circle, Elliptical or Circular Segment
- Available up to 84" Long and 42" Wide
- Variety of Edge Profiles -- Bullnose double with integral, impact-resilient profile, Straight with integral, impact-resilient profile or Straight plastic edging

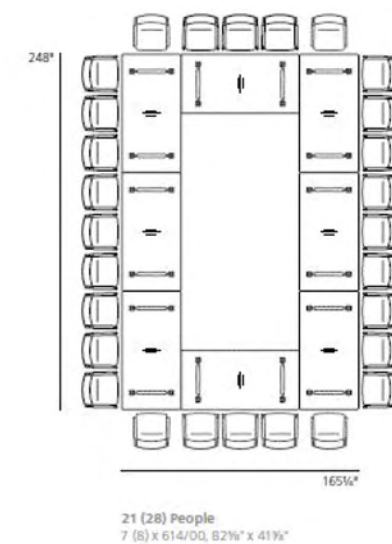
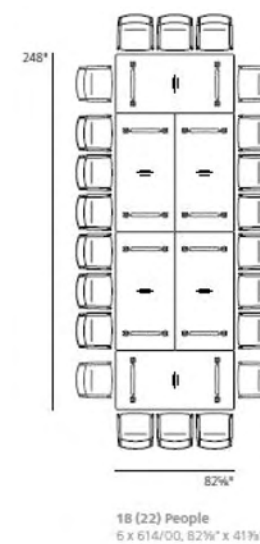
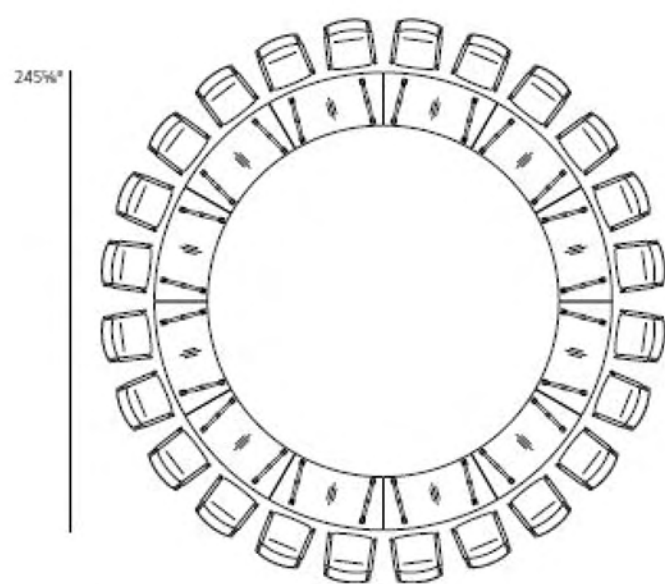



Wilkhahn



WWW.SLGROUPONLINE.COM

kate@slgrouponline.com | sandy@slgrouponline.com | sam@slgrouponline.com